

RETEVIS

RA86

Mobile Radio USER'S MANUAL

Contents

Users Safety Information -----	01
Notice Before Use -----	01
Main Features -----	01
Package Includes -----	01
Installing Your Radio -----	02
Radio Introduction -----	02
Keyboard Function Introduction -----	05
Menu Function Introduction -----	06
Reset Function -----	09
Factory Frequency Setting -----	09
CTCSS/DCS Frequency Table -----	10
Technical Specifications -----	12
WARNING -----	13

For downloading further resources:
Brochures, Software/Firmware, Manual etc, Pls contact
your direct reseller first OR go to website retevis.com and
check "support" in the each product link to download it.

Users Safety Information

- Do not attempt to configure your transceiver while driving.
- This transceiver is designed for a 13.8V DC power supply. Do not use a 24V battery to power on the transceiver.
- Please keep it away from interferential devices (Such as TVs, generators, etc.)
- Do not expose the transceiver to long periods of direct sunlight or place it close to heating appliances.
- If an abnormal odour or smoke is detected coming from the transceiver, turn off the power immediately and contact your dealer.
- Do not transmit with high power for extended periods or the transceiver may overheat.

Notice Before Use

Congratulations on your purchase of a high quality Retevis product.

RA86 is designed for General Mobile Radio Service (GMRS) operation. All Retevis GMRS radios can communicate with each other freely.

The frequency of GMRS is a shared frequency, and the possibility of interference is relatively high. So the RA86 factory frequency setting is with CTCSS/DCS.

If you don't want CTCSS/DCS in the factory setting, You can cancel the default CTCSS/DCS setting by doing the following.

1. Be sure the radio is turned off
 2. Press and hold the PTT and the Scan button simultaneously,
 3. With the buttons still held, turn on the radio.
- All default CTCSS/DCS settings will be cleared. (i.e. no CTCSS/DCS on all channels)

Mani Features

- 15 GMRS Channels
- 8 Repeater Channels
- 7 Receive Only Channels
- 10 NOAA Weather Channels
- 260 Privacy Codes (50 CTCSS, 105 DCS-N and 105 DCS-I)
- Monitor Function
- Mic Gain
- VOX
- Squelch
- Keypad Lock
- LCD Brightness Settings
- Bandwidth Settings
- Power Hi/Lo Settings
- Automatic Power On Function
- External Speaker Jack

Package Includes



Radio Base



Handheld Speaker Mic

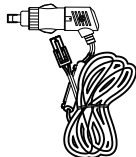

Car Charger with Fuse Holder



Screw Packs



Antenna

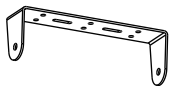

Mobile Mounting Bracket



Microphone Bracket

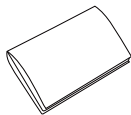

User Manual

Installing Your Radio

To install the transceiver select a safe and convenient location inside your vehicle that minimizes danger to your passengers and yourself while the vehicle is in motion. Also take into consideration the routing and length of the lead wires and cables to the power source, antenna, and/or optional external speaker.

Installing the Mounting Bracket

1. Using the mounting bracket as a template, mark the location of each screw hole. Use a nail or other sharp pointed object to mark the hole locations.
2. Attach the bracket with the Phillips head sheet metal screws provided. Tighten the screws securely. **DO NOT OVER-TIGHTEN.**
3. Slide the radio into the mounting bracket. **BE SURE** the mounting bracket retainers engage the slots in the sides of the radio to prevent movement while driving.

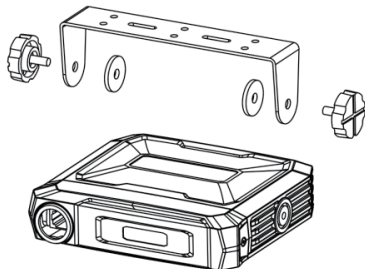

Installing the Antenna

The RA86 includes a "magnetic mount" antenna, intended to be attached to the vehicle's roof, trunk or similar location. Specific installation requirements vary between vehicles. The Antenna height is 0.54 feet (16.5cm) and the antenna cable is 16.4 feet (5 meters) long

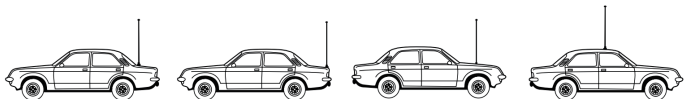

Electrical and Rear Panel Connections

The power cord supplied with the RA86 is equipped with a cigarette lighter adapter for easy installation. Simply plug the connector into the vehicle's cigarette lighter.

Connecting the Microphone

Insert the RJ45 connector into the front of the RA86. The microphone mounting bracket can be attached to the vehicle dash or other convenient location in a manner similar to the radio's mounting bracket.

Using an External Speaker

- The RA86 provides a rear-panel jack for connection of an optional external speaker (purchased separately).
- When selecting an external speaker, ensure the speaker has 8-ohm impedance and is rated for 4.0 watts.

NOTE: When an external speaker is connected, the radio's internal speaker is automatically disabled.

Radio Introduction

Speaker Mic

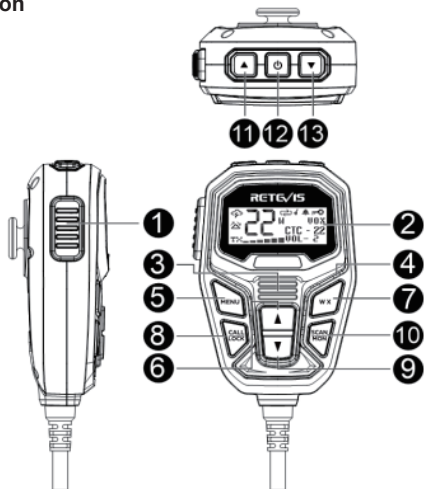

No.	Name	Short Press Function	Long Press Function
1	PTT		
2	LCD		
3	Speaker		
4	Speaker Microphone		
5	Menu	Enter menu, confirm selection and exit menu	
6	Volume+	Raise volume during standby, Function selection during menu	Raise volume during standby, Function selection during menu
7	WX	Enter weather mode	
8	Call/Lock	Press to send a call signal	Keypad Lock
9	Volume-	Lower the volume during standby, Function selection during menu	Lower the volume during standby, Function selection during menu
10	Scan/Mon	Enter/exit scan	Enable/disable monitor
11	Channel+	Increase the channel number	Rapidly increase the channel number
12	Power On/Off Button		Turn on/off the radio
13	Channel-	Decrease the channel number	Rapidly decrease the channel number

Rear panel

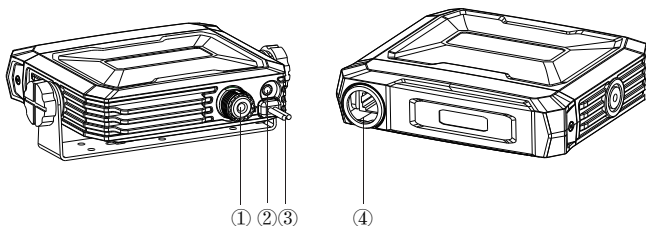

NO.	Key	Functions
1	Antenna connector	Connect a 50 ohm antenna
2	Ex-Speaker Jack	Connect external speaker
3	Power cable	Connect a standard DC power cable
4	Microphone Jack	Connect Handheld Speaker Mic

LCD Display

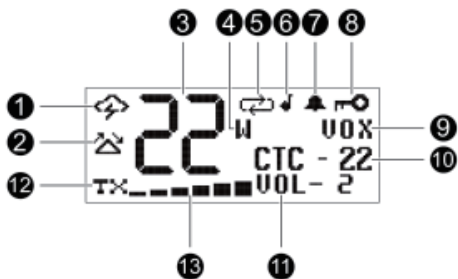

1		Indicates when the radio is in the Weather Band mode	8		Indicates KEY LOCK mode is on.
2		Shows the selected transmit/receive repeater channel.	9	VOX	Indicates VOX is on.
3	XX	Shows the selected transmit/receive channel.	10	CTC-XX	Indicates the selected CTCSS/DCS number
4	W/N	Shows the selected channel bandwidth is Wide/Narrow.	11	VOL-2	Volume level indicator
5		Indicates the "auto-scan" function is active.	12	TX	Indicates the radio is transmitting
6		Indicates roger beep is on		RX	Indicates the radio is receiving a transmission
7		Indicates key tone is on		HI/LO	Show high and low power during standby
			13	Field strength	Indicates the strength of the current transmit or receive signal.

Keypad Function Introduction

1. Power On/Off

With the radio off, press and hold the Power Button for three seconds. You will hear a tone when the radio is on.

•The LCD display will show Retevis icons for one second and then display the most recently selected channel.

With the radio on, press and hold the Power Button for three seconds.

•The LCD display will go blank when the radio turns off.

NOTE: In the case of an unnatural shutdown, the device can be turned on immediately after the next plug in.

2. Channel+/-

IMPORTANT! To communicate between two radios, both radios must be set to the same channel and CTCSS/DCS Code selections.

To Select the Active channel:

Short press the Channel+ button on the microphone to scroll forward through the available channels. Short press the Channel- button on the microphone to scroll backward through the available channels.

• Rapidly switch channel number by Long pressing the Channel+ or Channel-.

• The Channel icon on the LCD display will show the active channel.

3. PTT key

To transmit a call, press and hold the PTT button on the microphone, and speak into the microphone in a normal voice.

The TX icon and Signal Strength will show continuously on the LCD display while transmitting.

NOTE:

• For maximum clarity, hold the microphone 2 to 3 inches from your mouth when speaking.

• The 08-14 channel of the radio is only allowed to receive, not to transmit. The radio will have a long tone when you press PTT.

4. Keypad lock: Call/Lock

You can use the keypad "lock" function to prevent accidentally changing your radio's settings. When the function is enabled, the current radio settings are "locked" in place.

NOTE: When the "lock" function is enabled, the PTT button, Volume Buttons and the Call Button on the microphone remain active.

To "lock" and "unlock" the keypad:

Press and hold the Lock button for three seconds.

• The Keypad Lock icon will show on the LCD display when the keypad is "locked."

Press and hold the Lock button for three seconds again to "unlock" the keypad.

• The Keypad Lock icon will turn off when the keypad is "unlocked".

5. Call Alert Tone: Call/Lock

Retevis RA86 has 5 selectable Call Alert Tones.

Selecting a Call Alert Tone:

1. Short press the Menu button to place the radio in "Menu" mode.

2. Use the MENU button to scroll through the menu options until the LCD display shows CALL TONE.

3. Use the Volume Up or Volume Down button to scroll forward or backward through the tone options (01 - 05).

When scrolling through the 5 options the sound will be played for you.

4. When the desired tone is found, press the MENU button to confirm your selection. Radio will show the next setting. Or you can long press the MENU to save and exit the menu list directly.

6. Monitor: Scan/Mon

Monitor mode lets you check for activity on the current active channel. You can also use Monitor mode to adjust the volume of your radio when not receiving a signal.

To enter and exit Monitor mode:

Long press the Scan/Mon button to enter Monitor mode. You will hear any activity on the current selected channel.

In the monitor mode, you can adjust the volume by the volume key on the microphone.

Long press the Scan/Mon button to exit Monitor mode.

7. Scan: Scan/Mon

To enter and exit "auto-scan" mode:

Short press the Scan button to enter "auto-scan" mode.

• The Scanning icon will show on the LCD display when the radio is in "auto-scan" mode.

• Your radio will rapidly scan through the available channels and will pause on any active channel.

• "Auto-scan" will resume when there has been no activity on the current channel for four seconds.

To transmit during "auto scan," press and hold the PTT button on the microphone while the radio is paused on

the desired channel.

- The radio will remain on the active channel for ten seconds after the PTT button is released.
- To exit the "auto-scan" mode, Short press the Scan button.
- The Scanning icon will turn off when the radio is no longer in "auto-scan" mode.

8.NOAA Weather forecast:WX

Retevis RA86 has a NOAA Weather Radio function, to enable the user to receive weather reports from designated NOAA stations. Your radio also has a NOAA Weather Scan function, to enable the user to scan all 10 channels for the NOAA National Weather Service.

9.To enter and exit Weather Scan

Short press the Weather button to enter weather mode.

- The radio will then scan all 10 weather channels and stops when the weather channel receives the signal.
- When in scan mode, press the Channel+ or Channel- key, you can switch the scan direction. When scan is stop, press the Channel+ or Channel- key, you can switch the weather channel.

Press the PTT or WX key to exit Weather Mode.

10.To Manually Set the Weather Channel:

With the Weather Scan activated, press the Scan button to exit scanning mode.

- The Weather icon and active channel will stop flashing and will continuously be displayed on the LCD.
- Using the Channel Up or the Channel Down buttons on the microphone, manually set the active weather channel.

11.To Enable Weather Alert:

1. With Weather mode activated, press the Scan button to exit scanning mode.
- The weather icon and active channel will stop flashing and will continuously be displayed on the LCD.
2. Use the Channel Up or Channel Down on the microphone to select the desired Weather Channel.
3. Short press the MENU button to enter the weather forecast alarm switch setting, and use the volume button to select ON/ OFF, press and hold the MENU button again to complete the setting and return to the weather channel.
4. After the alarm function is enabled, when the radio is in the weather channel scanning mode, any channel receiving an alarm modulation of 1050HZ will trigger a weather forecast alarm.
5. When the radio is on the GMRS channel, it will also watch the weather channel (the watch weather channel is the channel where the user exits the weather forecast).

12.Weather alarm work mode

When the radio receives the signal of the alarm channel you set, it will alarm in this mode, and the alarm will cycle once every 20 seconds, and enter the weather forecast mode after the alarm.

Menu Mode Function Introduction

The user can set the function of the radio through the menu.

Note: In the process of menu setting, short PTT key or no operation within 5S will automatically exit the menu, the settings of the current menu will not be saved, and the menu that has been set will not be affected.

Channel Menu Quick Reference Chart

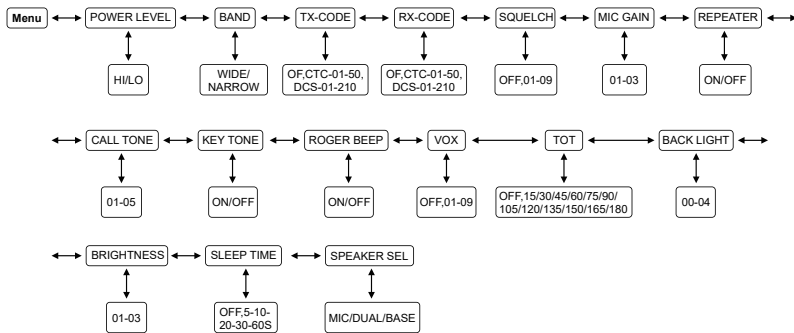

POWER LEVEL

Retevis RA86 provides two transmit power levels: HI and Lo. The Lo power level is generally suitable when operating under optimal conditions. The HI power level is recommended to ensure you get maximum range from your radio.

- Short press the MENU button in standby mode until the Power Level menu is displayed;
- Set high/low power by the volume keys on the mic (HI/LO) ;
- Short press the MENU button to save the settings and enter the next function menu, long press the MENU button to save the settings and exit the menu.

NOTE: Since the 01-07 channel is fixed as low power, when the radio is in the 01-07 channel, the Power Level menu will not be displayed.

BANDWIDTH

- In standby mode, short press the MENU button until the Band menu is displayed;
- Set wide/narrow band by the volume keys on the mic (Wide/Narrow) ;
- Short press the MENU button to save the settings and enter the next function menu, long press the MENU button to save the settings and exit the menu.

NOTE: Since the 08-14 channel is fixed as a narrowband frequency and is in a forbidden state, when the radio is in the 08-14 channel, the Band menu will not be displayed.

CTCSS/DCS

Continuous Tone Coded Squelch System (CTCSS) and Digitally Coded Squelch (DCS) are systems that allow several users to share the same channel without disturbing each other. When CTCSS or DCS is enabled for a selected channel, the channel is muted to all incoming signals unless they carry the correct CTCSS or DCS tone. When a transmission with the correct tone is received, the mute is removed and the voice audio can be heard. When the transmission ends the channel is muted again. Transmissions that do not have the correct tone are not heard.

The RA86 has 260 Privacy Codes (50 CTCSS, 105 DCS-N and 105 DCS-I), which can be applied to any channel. If desired, you can select a different Privacy Code for each channel. See CTCSS/DCS frequency Chart for lists of available Privacy Codes.

IMPORTANT! To communicate between two radios, both radios must be set to the same channel (see Selecting the Active Channel) and Privacy Code selections.

The transmitter and receiver CTCSS/DCS are set independently using the TX-CODE and RX-CODE menus. You can set different or same transmitter and receiver CTCSS/DCS for each channel. When the radio is in standby or receiving state, the LCD shows the receive CTCSS/DCS, when pressing PTT, it will show the transmit CTCSS/DCS.

TX-CODE

- In the standby state, short press the MENU button until the TX code menu is displayed;
- Use the volume keys on the microphone to set the transmit CTCSS/DCS (see CTCSS/DCS frequency Chart);
- Short press the MENU button to save the settings and enter the next function menu, long press the MENU button to save the settings and exit the menu.

NOTE:

1. When in the transmitting state, the LCD will display the set transmitting CTCSS/DCS.
2. In the CTCSS/DCS setting interface, you can switch the display CTCSS/DCS number or CTCSS/DCS frequency by short pressing the SCAN/MON key, and then short press the MENU key to confirm the display mode.

RX-CODE

- In the standby state, short press the MENU button until the TX code menu is displayed;
- Use the volume keys on the microphone to set the transmit CTCSS/DCS (see CTCSS/DCS frequency Chart);
- Short press the MENU button to save the settings and enter the next function menu, long press the MENU button to save the settings and exit the menu.

NOTE:

1. When the radio is in standby or receiving state, the LCD will display the set receiving CTCSS/DCS.
2. In the CTCSS/DCS setting interface, you can switch the display CTCSS/DCS number or CTCSS/DCS frequency by short pressing the SCAN/MON key, and then short press the MENU key to confirm the display mode.

If you select the CTCSS/DCS number, It prevents others from easily know your CTCSS/DCS frequency, This prevents you from receiving a lot of unwanted voice signal. If you want to know the frequency represented by the number, you can switch to frequency freely. This is a different display way, you can switch freely depending on the usage environment.

SQUELCH

The RA86 has adjustable squelch sensitivity. The minimum squelch level of 01 is the most sensitive, which allows the squelch to open on very weak signals. Setting the squelch to the maximum setting of 09 requires very strong signals to open the squelch.

- In standby mode, short press the MENU button until the SQUELCH menu is displayed;
- Set the squelch level through the volume key on the hand microphone (OFF, 01-09);
- Short press the MENU button to save the settings and enter the next function menu, long press the MENU button to save the settings and exit the menu.

MIC GAIN

Different usage environment needs different microphone sensitivity. The RA86 has adjustable microphone sensitivity.

- Short press the MENU button in standby mode until the Mic Gain menu is displayed;
- Set the microphone gain level (01-03, of which level 03 has the highest microphone gain) by the volume keys on the hand microphone;
- Short press the MENU button to save the settings and enter the next function menu, long press the MENU button to save the settings and exit the menu.

REPEATER

Your RA86 has the ability to access repeater channels. The use of a repeater can significantly increase a radio's range and coverage area.

Prior to using a repeater you must coordinate with the owner of the repeater to gain permission to use the repeater. Be sure to understand and follow the sharing and usage rules for each repeater system.

- Short press the MENU button in standby mode until the Repeater menu is displayed;
- Use the Volume Up or Volume Down button to select ON or OFF.
- Short press the MENU button to save the settings and enter the next function menu, long press the MENU button to save the settings and exit the menu.

NOTE: When activated the repeater channels will be displayed as the channel number (Ex. 15,16,17,etc.) and the repeater icon.

CALL TONE

The RA86 has 5 selectable Call Alert Tones.

- Short press the MENU button in standby mode until the Call Tone menu is displayed;
- Use the Volume Up or Volume Down button to scroll forward or backward through the tone options (01 - 05). When scrolling through the 5 options the sound will be played for you;
- Short press the MENU button to save the settings and enter the next function menu, long press the MENU button to save the settings and exit the menu.

KEY TONE

The RA86 has a Silent Operation mode. In this mode, all "beeps" and "tones" are disabled.

- Short press the MENU button in standby mode until the Key Tone menu is displayed;
- Use the Volume Up or Volume Down button to select ON or OFF;
- Short press the MENU button to save the settings and enter the next function menu, long press the MENU button to save the settings and exit the menu.

ROGER BEEP

When the PTT button on the mic is released, the radio will beep to confirm to other users that your transmission is complete.

- Short press the MENU button in standby mode until the Roger Beep menu is displayed;
- Use the Volume Up or Volume Down button to select ON or OFF.
- Short press the MENU button to save the settings and enter the next function menu, long press the MENU button to save the settings and exit the menu.

VOX

- Short press the MENU button in standby mode until the VOX Level menu is displayed;
- Use the Volume Up or Volume Down button to select the VOX level (OFF, 01-09, of which level 09 is the most sensitive);
- Short press the MENU button to save the settings and enter the next function menu, long press the MENU button to save the settings and exit the menu.

TOT

- Short press MENU in standby state until the TOT menu is displayed;
- Use the Volume Up or Volume Down button to select the TOT time (up to 180s) ;
- Short press the MENU button to save the settings and enter the next function menu, long press the MENU button to save the settings and exit the menu.

BACKLIGHT

The RA86 has 4 different color options for the LCD Display background.

- Short press the MENU button in standby mode until the Backlight menu is displayed;
- Use the Volume Up or Volume Down button to select the LCD Display background color (00-04, 00 is to turn off the backlight);
- Short press the MENU button to save the settings and enter the next function menu, long press the MENU button to save the settings and exit the menu.

BRIGHTNESS

The RA86 has 3 different screen brightness.

- Short press the MENU key in standby mode until the Brightness menu is displayed;
- Use the Volume Up or Volume Down button to select the backlight brightness level (01-03).
- Short press the MENU button to save the settings and enter the next function menu, long press the MENU button to save the settings and exit the menu.

SLEEP TIME

- In standby mode, short press the MENU button until the Sleep Time menu is displayed;
- Use the Volume Up or Volume Down button to select the sleep time (OFF/5S/10S/20S/30S/60S) .
- Short press the MENU button to save the settings and enter the next function menu, long press the MENU button to save the settings and exit the menu.

When the sleep function takes effect, the LCD backlight and key backlight of the radio will be turned off, and will enter the power saving mode, but the LCD will still display normally.

SPEAKER SELECT

The RA86 has two speakers. You can choose which speaker you would like to use for your audio.

- Short press the MENU button in standby mode until the Speaker Sel menu is displayed;
- Use the Volume Up or Volume Down button to select the speaker status (Base/MIC/DUAL) .
- Short press the MENU button to save the settings and enter the next function menu, long press the MENU button to save the settings and exit the menu.

Display Option	Description
BASE	Radio Base Speaker is Active. Handheld Speaker is Off.
MIC	Handheld Speaker is Active. Radio Base Speaker is Off.
DUAL	Both the Handheld and the Radio Base Speakers are active.

RESTORING THE DEFAULT SETTINGS

You can restore the original (factory default) settings for your RA86 at any time.

- 1.Be sure the radio is turned off
 - 2.Press and hold the PTT and the WX button simultaneously,
 - 3.With the buttons still held, turn on the radio.
- During the reset process, the LCD will display the current software version number;
 - After the reset is completed, all the settings of the radio is restored to the factory state.

Factory frequency chart

CH NO.	TX Frequency(MHz)	RX Frequency(MHz)	Code(Hz)	Power
1	462.5625	462.5625	67.0	Low
2	462.5875	462.5875	118.8	Low
3	462.6125	462.6125	127.3	Low
4	462.6375	462.6375	131.8	Low
5	462.6625	462.6625	136.5	Low
6	462.6875	462.6875	141.3	Low
7	462.7125	462.7125	146.2	Low
8	/	467.5625	D243N	Low
9	/	467.5875	D032N	Low
10	/	467.6125	D047N	Low
11	/	467.6375	D051N	Low
12	/	467.6625	D053N	Low

CH NO.	TX Frequency(MHz)	RX Frequency(MHz)	Code(Hz)	Power
13	/	467.6875	D065N	Low
14	/	467.7125	D116N	Low
15	462.5500	462.5500	123.0	High
16	462.5750	462.5750	D743I	High
17	462.6000	462.6000	D332I	High
18	462.6250	462.6250	127.3	High
19	462.6500	462.6500	D243I	High
20	462.6750	462.6750	D606N	High
21	462.7000	462.7000	D731I	High
22	462.7250	462.7250	136.5	High
15RP	467.5500	462.5500	-	High
16RP	467.5750	462.5750	-	High
17RP	467.6000	462.6000	-	High
18RP	467.6250	462.6250	-	High
19RP	467.6500	462.6500	-	High
20RP	467.6750	462.6750	-	High
21RP	467.7000	462.7000	-	High
22RP	467.7250	462.7250	-	High

Weather forecast channel frequency table

Channel	RX	Channel	RX
1	162.5500	6	162.5000
2	162.4000	7	162.5250
3	162.4750	8	161.6500
4	162.4250	9	161.7750
5	162.4500	10	163.2750

CTCSS/DCS frequency table

CTCSS

NO.	Code	NO.	Code	NO.	Code	NO.	Code
CTC-01	67.0	CTC-15	85.4	CTC-29	165.5	CTC-43	210.7
CTC-02	69.3	CTC-16	88.5	CTC-30	167.9	CTC-44	218.1
CTC-03	71.9	CTC-17	91.5	CTC-31	171.3	CTC-45	225.7
CTC-04	74.4	CTC-18	94.8	CTC-32	173.8	CTC-46	229.1
CTC-05	77.0	CTC-19	97.4	CTC-33	177.3	CTC-47	233.6
CTC-06	79.7	CTC-20	100.0	CTC-34	179.9	CTC-48	241.8
CTC-07	82.5	CTC-21	103.5	CTC-35	183.5	CTC-49	250.3
CTC-08	85.4	CTC-22	136.5	CTC-36	186.2	CTC-50	254.1
CTC-09	88.5	CTC-23	141.3	CTC-37	189.9		
CTC-10	91.5	CTC-24	146.2	CTC-38	192.8		
CTC-11	94.8	CTC-25	151.4	CTC-39	196.6		
CTC-12	97.4	CTC-26	156.7	CTC-40	199.5		
CTC-13	100.0	CTC-27	159.8	CTC-41	203.5		
CTC-14	103.5	CTC-28	162.2	CTC-42	206.5		

DCS

NO.	Code	NO.	Code	NO.	Code	NO.	Code	NO.	Code
DCS-001	D023N	DCS-043	D251N	DCS-085	D532N	DCS-127	D131I	DCS-169	D371I
DCS-002	D025N	DCS-044	D252N	DCS-086	D546N	DCS-128	D132I	DCS-170	D411I
DCS-003	D026N	DCS-045	D255N	DCS-087	D565N	DCS-129	D134I	DCS-171	D412I
DCS-004	D031N	DCS-046	D261N	DCS-088	D606N	DCS-130	D143I	DCS-172	D413I
DCS-005	D032N	DCS-047	D263N	DCS-089	D612N	DCS-131	D145I	DCS-173	D423I
DCS-006	D036N	DCS-048	D265N	DCS-090	D624N	DCS-132	D152I	DCS-174	D431I
DCS-007	D043N	DCS-049	D266N	DCS-091	D627N	DCS-133	D155I	DCS-175	D432I
DCS-008	D047N	DCS-050	D271N	DCS-092	D631N	DCS-134	D156I	DCS-176	D445I
DCS-009	D051N	DCS-051	D274N	DCS-093	D632N	DCS-135	D162I	DCS-177	D446I
DCS-010	D053N	DCS-052	D306N	DCS-094	D645N	DCS-136	D165I	DCS-178	D452I
DCS-011	D054N	DCS-053	D311N	DCS-095	D654N	DCS-137	D172I	DCS-179	D454I
DCS-012	D065N	DCS-054	D315N	DCS-096	D662N	DCS-138	D174I	DCS-180	D455I
DCS-013	D071N	DCS-055	D325N	DCS-097	D664N	DCS-139	D205I	DCS-181	D462I
DCS-014	D072N	DCS-056	D331N	DCS-098	D703N	DCS-140	D212I	DCS-182	D464I
DCS-015	D073N	DCS-057	D332N	DCS-099	D712N	DCS-141	D223I	DCS-183	D465I
DCS-016	D074N	DCS-058	D343N	DCS-100	D723N	DCS-142	D225I	DCS-184	D466I
DCS-017	D114N	DCS-059	D346N	DCS-101	D731N	DCS-143	D226I	DCS-185	D503I
DCS-018	D115N	DCS-060	D351N	DCS-102	D732N	DCS-144	D243I	DCS-186	D506I
DCS-019	D116N	DCS-061	D356N	DCS-103	D734N	DCS-145	D244I	DCS-187	D516I
DCS-020	D122N	DCS-062	D364N	DCS-104	D743N	DCS-146	D245I	DCS-188	D523I
DCS-021	D125N	DCS-063	D365N	DCS-105	D754N	DCS-147	D246I	DCS-189	D526I
DCS-022	D131N	DCS-064	D371N	DCS-106	D023I	DCS-148	D251I	DCS-190	D532I
DCS-023	D132N	DCS-065	D411N	DCS-107	D025I	DCS-149	D252I	DCS-191	D546I
DCS-024	D134N	DCS-066	D412N	DCS-108	D026I	DCS-150	D255I	DCS-192	D565I
DCS-025	D143N	DCS-067	D413N	DCS-109	D031I	DCS-151	D261I	DCS-193	D606I
DCS-026	D145N	DCS-068	D423N	DCS-110	D032I	DCS-152	D263I	DCS-194	D612I
DCS-027	D152N	DCS-069	D431N	DCS-111	D036I	DCS-153	D265I	DCS-195	D624I
DCS-028	D155N	DCS-070	D432N	DCS-112	D043I	DCS-154	D266I	DCS-196	D627I
DCS-029	D156N	DCS-071	D445N	DCS-113	D047I	DCS-155	D271I	DCS-197	D631I
DCS-030	D162N	DCS-072	D446N	DCS-114	D051I	DCS-156	D274I	DCS-198	D632I
DCS-031	D165N	DCS-073	D452N	DCS-115	D053I	DCS-157	D306I	DCS-199	D645I
DCS-032	D172N	DCS-074	D454N	DCS-116	D054I	DCS-158	D311I	DCS-200	D654I
DCS-033	D174N	DCS-075	D455N	DCS-117	D065I	DCS-159	D315I	DCS-201	D662I
DCS-034	D205N	DCS-076	D462N	DCS-118	D071I	DCS-160	D325I	DCS-202	D664I
DCS-035	D212N	DCS-077	D464N	DCS-119	D072I	DCS-161	D331I	DCS-203	D703I
DCS-036	D223N	DCS-078	D465N	DCS-120	D073I	DCS-162	D332I	DCS-204	D712I
DCS-037	D225N	DCS-079	D466N	DCS-121	D074I	DCS-163	D343I	DCS-205	D723I
DCS-038	D226N	DCS-080	D503N	DCS-122	D114I	DCS-164	D346I	DCS-206	D731I
DCS-039	D243N	DCS-081	D506N	DCS-123	D115I	DCS-165	D351I	DCS-207	D732I
DCS-040	D244N	DCS-082	D516N	DCS-124	D116I	DCS-166	D356I	DCS-208	D734I
DCS-041	D245N	DCS-083	D523N	DCS-125	D122I	DCS-167	D364I	DCS-209	D743I
DCS-042	D246N	DCS-084	D526N	DCS-126	D125I	DCS-168	D365I	DCS-210	D754I

Technical Specifications

GENERAL	
Frequency Range	GMRS
Number of Channels	30 channels
Channel Spacing	20K (Wide Band) 12.5K (Narrow band)
Operating Voltage	DC 13.8V (Standard version) DC 12.6-14.4V (Optional version)
Frequency Stability	±2.5ppm
Operating Temperature	-30 C ~+55 C

RECEIVER	
Adjacent Channel Selectivity	≥60dB
Receiving sensitivity	≤-122m@SINAD=12dB
Audio distortion	≤8%
Audio power output	3.2v-4.2v@8R SPK@AF=1KHz.FM Devation=1.5KHZ

TRANSMITTER	
Power Output	≤20W
Modulation	FM



ATTENTION!

Before using this radio, read this guide which contains important operating instructions for safe usage and rf energy awareness and control for compliance with applicable standards and regulations.

- User instructions should accompany the device when transferred to other users.**
- Do not use this device if the operational requirements described herein are not met.**

This two-way radio uses electromagnetic energy in the radio frequency (RF) spectrum to provide communications between two or more users over a distance. RF energy, which when used improperly, can cause biological damage.

All Retevis two-way radios are designed, manufactured, and tested to ensure they meet government-established RF exposure levels. In addition, manufacturers also recommend specific operating instructions to users of two-way radios. These instructions are important because they inform users of RF energy exposure and provide simple procedures on how to control it.

Please refer to the following websites for more information on what RF energy exposure is and how to control your exposure to assure compliance with established RF exposure limits: <http://www.who.int/en/> When two-way radios are used as a consequence of employment, the Local Government Regulations requires users to be fully aware of and able to control their exposure to meet occupational requirements. Exposure awareness can be facilitated by the use of a product label directing users to specific user awareness information. Your Retevis two-way radio has a RF Exposure Product Label. Also, your Retevis user manual, or separate safety booklet includes information and operating instructions required to control your RF exposure and to satisfy compliance requirements.

Radio License(only applicable to licensed radio)

Governments(keep the radios in classification, business two-way radios operate on radio frequencies that are regulated by the local radio management departments (FCC, ISED, OFCOM, ANFR, BFTK, Bundesnetzagentur...).To transmit on these frequencies, you are required to have a license issued by them. The detailed classification and the use of your two radios, please contact the local government radio management departments.

Use of this radio outside the country where it was intended to be distributed is subject to government regulations and may be prohibited.

Unauthorized modification and adjustment

Changes or modifications not expressly approved by the party responsible for compliance may void the user's authority granted by the local government radio management departments to operate this radio and should not be made. To comply with the corresponding requirements, transmitter adjustments should be made only by or under the supervision of a person certified as technically qualified to perform transmitter maintenance and repairs in the private land mobile and fixed services as certified by an organization representative of the user of those services.

Replacement of any transmitter component (crystal, semiconductor, etc.) not authorized by the local government radio management departments equipment authorization for this radio could violate the rules.

FCC Requirements:

This device complies with part 15 of the FCC Rules. Operation is subject to the condition that this device does not cause harmful interference.

(Only Applicable to GMRS radio station):

A valid individual license is required to operate a GMRS station. To obtain an individual license, an applicant must be eligible and follow the applicable rules and procedures established by FCC. The applicant must pay the required application and regulatory fees. Each individual license in the GMRS will normally have a term of ten years from the date of grant or renewal, and may be renewed pursuant to the procedures of FCC. To obtain a GMRS operator license, you need FCC Form 605 & 159, we suggest visiting the FCC website at <https://www.fcc.gov/wireless/support/fcc-form-605>, which includes necessary instructions. More questions about the license application, please contact the FCC at 1-888-225-5322 or go to the FCC's website: <http://www.fcc.gov>. According to FCC rules, any individual who holds an individual license may allow his or her immediate family

members to operate his or her GMRS station or stations. Immediate family members are the licensee's spouse, children, grandchildren, stepchildren, parents, grandparents, stepparents, brothers, sisters, aunts, uncles, nieces, nephews, and in-laws.

This equipment has been tested and found to comply with the limits for a Class B digital device, pursuant to part 15 of the FCC Rules. These limits are designed to provide reasonable protection against harmful interference in a residential installation. This equipment generates, uses and can radiate radio frequency energy and, if not installed and used in accordance with the instructions, may cause harmful interference to radio communications. However, there is no guarantee that interference will not occur in a particular installation. If this equipment does cause harmful interference to radio or television reception, which can be determined by turning the equipment off and on, the user is encouraged to try to correct the interference by one or more of the following measures:

- Reorient or relocate the receiving antenna.
- Increase the separation between the equipment and receiver.
- Connect the equipment into an outlet on a circuit different from that to which the receiver is connected.
- Consult the dealer or an experienced radio/TV technician for help.

•Disposal

The crossed-out wheeled-bin symbol on your product, literature, or packaging reminds you that in the European Union, all electrical and electronic products, batteries, and accumulators (rechargeable batteries) must be taken to designated collection locations at the end of their working life. Do not dispose of these products as unsorted municipal waste. Dispose of them according to the laws in your area.



RF Exposure Compliance and Control Guidelines and Operating Instructions

•General population/uncontrolled Radio, this radio is designed for and classified as "General population/uncontrolled Use".

To control your exposure and ensure compliance with the occupational/controlled environment exposure limits, always adhere to the following procedures. When operating in front of the face, worn on the body, always place the radio in a Retevis approved clip, holder, holster, case, or body harness for this product. Using approved body-worn accessories is important because the use of Non-Retevis approved accessories may result in exposure levels, which exceed the IEEE/ICNIRP RF exposure limits.

Transmit no more than the rated duty factor of 50% of the time. To Transmit (Talk), push the Push to Talk (PTT) button. To receive calls (listen), release the PTT button. Transmitting necessary information or less, is important because the radio generates measurable RF energy exposure only when transmitting in terms of measuring for standards compliance.

- DO NOT operate the radio without a proper antenna attached, as this may damage the radio and may also cause you to exceed RF exposure limits. A proper antenna is the antenna supplied with this radio by the manufacturer or an antenna specifically authorized by the manufacturer for use with this radio, and the antenna gain shall not exceed the specified gain by the manufacturer declared.
- DO NOT transmit for more than 50% of total radio use time, more than 50% of the time can cause RF exposure compliance requirements to be exceeded.
- During transmissions, your radio generates RF energy that can possibly cause interference with other devices or systems. To avoid such interference, turn off the radio in areas where signs are posted to do so.
- DO NOT operate the transmitter in areas that are sensitive to electromagnetic radiation such as hospitals, aircraft, and blasting sites.
- Mobile Device, during operation, the separation distance between user and the antenna subjects to actual regulations, this separation distance will ensure that there is sufficient distance from a properly installed externally-mounted antenna to satisfy the RF exposure requirements. Transmit only when people outside the vehicle are at least the recommended minimum lateral distance away from a properly installed according to installation instructions, externally mounted antenna.

Electromagnetic Interference/Compatibility

NOTE: Nearly every electronic device is susceptible to electromagnetic interference (EMI) if inadequately shielded, designed, or otherwise configured for electromagnetic compatibility.

Avoid Choking Hazard



Small Parts. Not for children under 3 years.

Turn off your radio power in the following conditions:



- Turn off your radio before removing (installing) a battery or accessory or when charging battery.
- Turn off your radio when you are in a potentially hazardous environments: Near electrical blasting caps, in a blasting area, in explosive atmospheres (flammable gas, dust particles, metallic powders, grain powders, etc.).
- Turn off your radio while taking on fuel or while parked at gasoline service stations. To avoid electromagnetic interference and/or compatibility conflicts
- Turn off your radio in any facility where posted notices instruct you to do so, hospitals or health care facilities (Pacemakers, Hearing Aids and Other Medical Devices) may be using equipment that is sensitive to external RF energy.
- Turn off your radio when on board an aircraft. Any use of a radio must be in accordance with applicable regulations per airline crew instructions.

Protect your hearing:



- Use the lowest volume necessary to do your job.
- Turn up the volume only if you are in noisy surroundings.
- Turn down the volume before adding headset or earpiece.
- Limit the amount of time you use headsets or earpieces at high volume.
- When using the radio without a headset or earpiece, do not place the radio's speaker directly against your ear
- Use careful with the earphone maybe possible excessive sound pressure from earphones and headphones can cause hearing loss

Note: Exposure to loud noises from any source for extended periods of time may temporarily or permanently affect your hearing. The louder the radio's volume, the less time is required before your hearing could be affected. Hearing damage from loud noise is sometimes undetectable at first and can have a cumulative effect.



Avoid Burns



Antennas

- Do not use any radio that has a damaged antenna. If a damaged antenna comes into contact with the skin when the radio is in use, a minor burn can result.
- Long transmission
- When the transceiver is used for long transmissions, the radiator and chassis will become hot.

Safety Operation



Forbid

- Do not use charger outdoors or in moist environments, use only in dry locations/conditions.
- Do not disassemble the charger, that may result in risk of electrical shock or fire.
- Do not operate the charger if it has been broken or damaged in any way.
- Do not place a portable radio in the area over an air bag or in the air bag deployment area. The radio may be propelled with great force and cause serious injury to occupants of the vehicle when the air bag inflates.
- To reduce risk
- Pull by the plug rather than the cord when disconnecting the charger.
- Unplug the charger from the AC outlet before attempting any maintenance or cleaning.
- Contact Retevis for assistance regarding repairs and service.
- The adapter shall be installed near the equipment and shall be easily accessible

Approved Accessories



• This radio meets the RF exposure guidelines when used with the Retevis accessories supplied or designated for the product. Use of other accessories may not ensure compliance with the RF exposure guidelines and may violate regulations.

- For a list of Retevis-approved accessories for your radio model, visit the following website: <http://www.Retevis.com>

Guarantee

Model Number: _____

Serial Number: _____

Purchasing Date: _____

Dealer: _____ Telephone: _____

User's Name: _____ Telephone: _____

Country: _____ Address: _____

Post Code: _____ Email: _____

Remarks:

1. This guarantee card should be kept by the user, no replacement if lost.
2. Most new products carry a two-year manufacturer's warranty from the date of purchase. Further details, pls read <http://www.retevis.com/after-sale/>
3. The user can get warranty and after-sales service as below:
 - Contact the seller where you buy.
 - Products Repaired by Our Local Repair Center
4. For warranty service, you will need to provide a receipt proof of purchase from the actual seller for verification

Exclusions from Warranty Coverage:

1. To any product damaged by accident.
2. In the event of misuse or abuse of the product or as a result of unauthorized alterations or repairs.
3. If the serial number has been altered, defaced, or removed.



CE FC RoHS



Shenzhen Retevis Technology Co.,Ltd.

7/F, 13-C, Zhonghaixin Science&Technology Park, No.12 Ganli
6th Road, Jihua Street, Longgang District, Shenzhen, China

Web:www.retevis.com
E-mail:kam@retevis.com

Facebook:facebook.com/retevis



MADE IN CHINA

说明书要求

尺寸：120*160mm

印刷：黑白印刷

装订：胶黏订

纸张材质：双胶纸

本页无需印刷