



Shenzhen Retevis Technology Co.,Ltd

Address:Room 700 , 7/F , Zhonghaixin Science&Technology Park ,
No.12 Ganli 6th Road , Buji Street , Longgang District, Shenzhen , China
Web:www.retevis.com E-mail:kam@retevis.com
Facebook : facebook.com/retevis



MADE IN CHINA



USER'S MANUAL RT50



14x12.5cm

TO CUSTOMERS

Thank you very much for using our DMR TDMA/FM two way radio. This product has a newly developed, structure reasonable beautiful design and feature stable. Small appearance design for user convenience operate. Please reading carefully before you using.

Welcome to use our company two way radio

Professional FM Transceiver

Main Function

Monitor

Battery save/low voltage alert

Lone work

End tone emilination

Low power prompt

PC program

Talkround

198channels

Operate in both Digital/ananlog mode

Encryption

High /Low power selectable

TOT

Chinese/English voice prompt

Busy lock

Feature Updated

QT

DQT

Wide/Narrow selectable

Single / group call

IP67 Waterproof

2time slot direct mode

2Tone/5tone signaling operation

Scrambler

Compander

Scan

CTCSS/DCS

Remote stun/active

Man down



Contents

- 02 Unpacking and checking equipment**
- 03 Charging the battery**
- 04 Using the battery**
- 06 Install and uninstalling of the accessory**
- 09 Getting Acquainted**
- 12 Digital tube letter feature**
- 13 Side key PC programming function**
- 18 Remote Kill /stun feature**
- 20 Font feature LED Display**
- 21 Radio setting**
- 25 Standard CTCSS And DCS setting**
- 27 Specifications**
- 29 Trouble shooting guide**
- Guarantee**

Using tips
Unpacking and checking equipment
Using the battery

Professional FM Transceiver

Using tips

Please read the following brief instructions, non-compliance with these rules may cause danger or violate the law.

- Obey the local government regulation before using this radio, improper use may violate the law and be punished.
- Turn off the radio before entering flammable or explosive areas.
- Do not charge or change the battery in flammable or explosive areas.
- Turn off the radio before getting close to the blasting zone or detonator areas.
- Do not use radio whose antenna is damaged, touching of demaged antenna will cause heat injury.
- Do not attempt to open the radio; the maintenance work should be done by technical expert only.
- To avoid troubles caused by electromagnetic interference or electromagnetic compatibility, please turn off the radio in places where have the banner "Do not use wireless equipment", such as hospital and other healthcare places.
- In the car with an airbag, do not put the radio within the scope of the airbag deployment.
- Do not store the radio under the direct sunshine or in hot areas.
- When you transmit with the radio, do keep away from its antenna for 5cm at least.
- If the radio appears smelly or smoke, please shut off its power immediately and contact with your local dealer.
- Do not transmit too long, for the radio may heat and hurt the user.

Unpacking and checking equipment

Carefully unpack the radio. We recommend you check the items listed in the following table before discarding the package. If any items is missing or has been damaged during shipment. Please contact us immediately.

Supplied Accessories

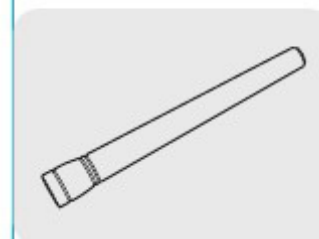

Antenna(1)



Li-ion battery(1)

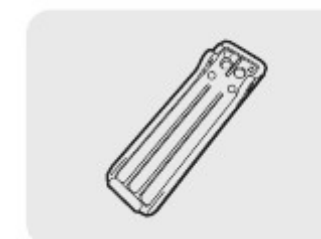

Belt clip(1)



Charger(1)



Adapter(1)



Users manual(1)



Verification(1)

Charging operations

Charge the battery as follow:

- Use the 110V/220V AC for charging plug.
- Insert the battery or radio with battery vertically in a charger.
- Make sure the battery and charger terminal is in good contact, when the charging indicator light turns red. Its starts charging.
- Charging around 4hours , Charging finished when the light turn green.battery or the radio will battery can be use normal .

Note:

- Before inserting the battery, it is abnormal if the charging indicator blinks.
- To change the battery for charging, please wait until the indicator is stable.
- When the battery is well inserted, the indicator turns red and the charging is on the process, If the indicator blinks. Then the battery is damaged or the temperature is too high or too low .
- Do not hold the antenna or micphone.
- Please cover the earphone jack when turn off the radio.
- Please use neutral wash solution for radio while use radios long time.

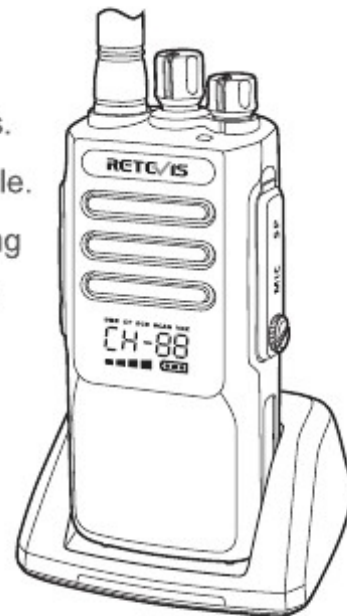

Charging precautions

The battery is not fully charged in factory, please charge before using it . Charge and discharge the battery for two or three times. The battery capacity will reach the best condition. When the battery capacity is low , please charge or change the battery.The battery lasts shortly even If it is fully charged. The battery is exhausted, please contact your local dealer to buy a new authentic battery .

Battery Type

Please use the factory assigned battery for charger.it maybe explode and harm to human body if use others battery .Please do not short-circuit the battery terminal or expose of in fire. Do not disassemble the battery by yourself.Charge the battery between temperature 0-45. the battery can not be fully charged beyond this temperature range.Please turn off the power when you charge the radio with battery, transmit with the radio in charge will affect its correct charge.

Do not unplug the power or battery when its charged.The operating time becomes short even the battery is fully charged, the battery is exhausted, please replace battery. Please do not charge when the battery or the radio is wet. Please dry it with a cloth before charging to avoid any danger.

Warning

When the conductive metals such as jewelery, key or decorative chains touch the battery terminals, all the batteries are likely to cause damage to the items or personal injury. These conductive metals may from a short circuit and generates much heat.Do deal with any battery carefully, especially whenput it into pocket.wallet or other metallic containers.

Install and uninstaling of the accessory Getting Acquainted

Professional FM Transceive

Install and uninstaling of the accessory

Installing / removing the battery

Align the two way radio grooves of battery and the guide rail on the back of aluminum shell.

Ensuring full contact and in parallel, then push the battery up to the radio base along the rail on the back of aluminum shell, until the battery latch locks up .

To remove the battery, please make sure the radio is closed, puch the battery latch down, and make sure the radio and battery is on the releasing state, and then puch the battery out from the radio.

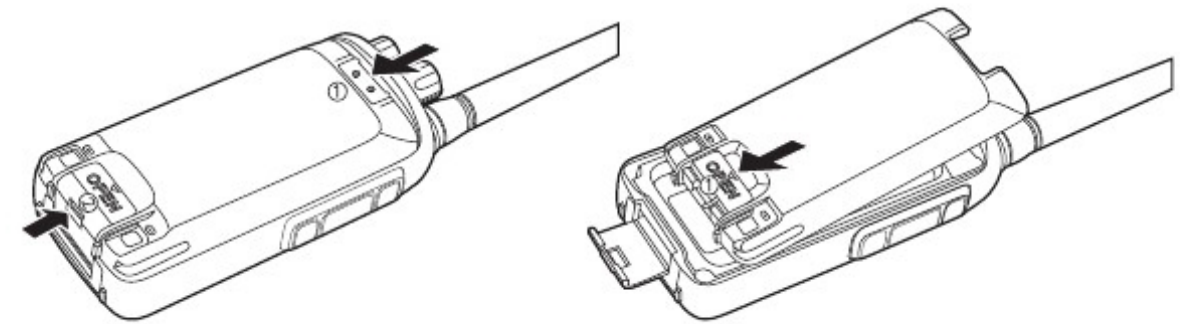

Installing and removing the antenna

Align the threaded end of antenna and the threaded hole at the top of radio. Rotate the antenna clockwise until it is tight .

To remove the antenna, rotate it counter-clockwise until the antenna spirals out .

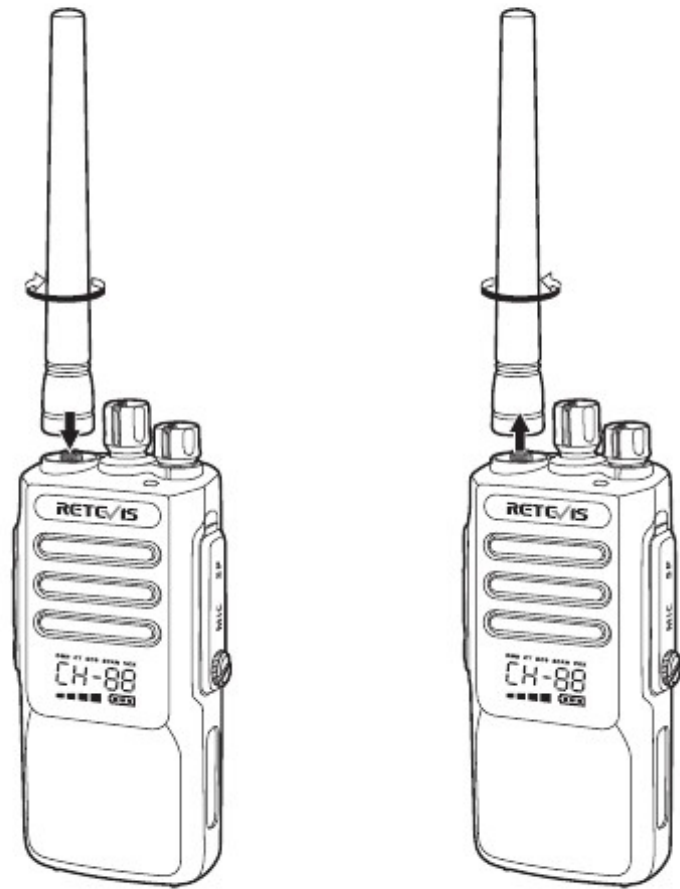

Installing external headset

Reveal the mic/speaker jack cover , insert the headset into the mic/speaker jack.

Note: Please contact with your local dealer for PC programming software.

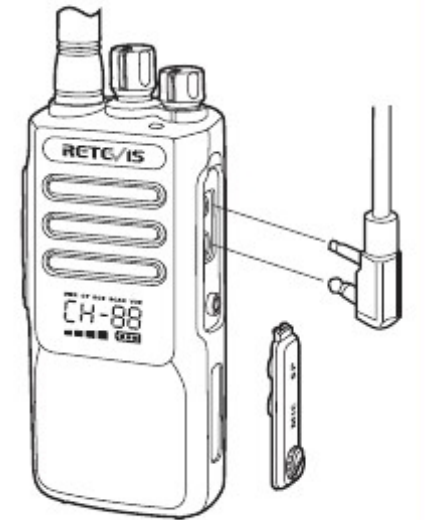

Installing and removing the belt clip

Installing belt clip

1. Remove the battery
2. Align the two holes of belt clip and the two holes of the radio, fix them with the supplied screw.

Removing the belt clip

1. Remove the battery
2. Loosen the screw set to remove the belt clip .



Getting Acquainted

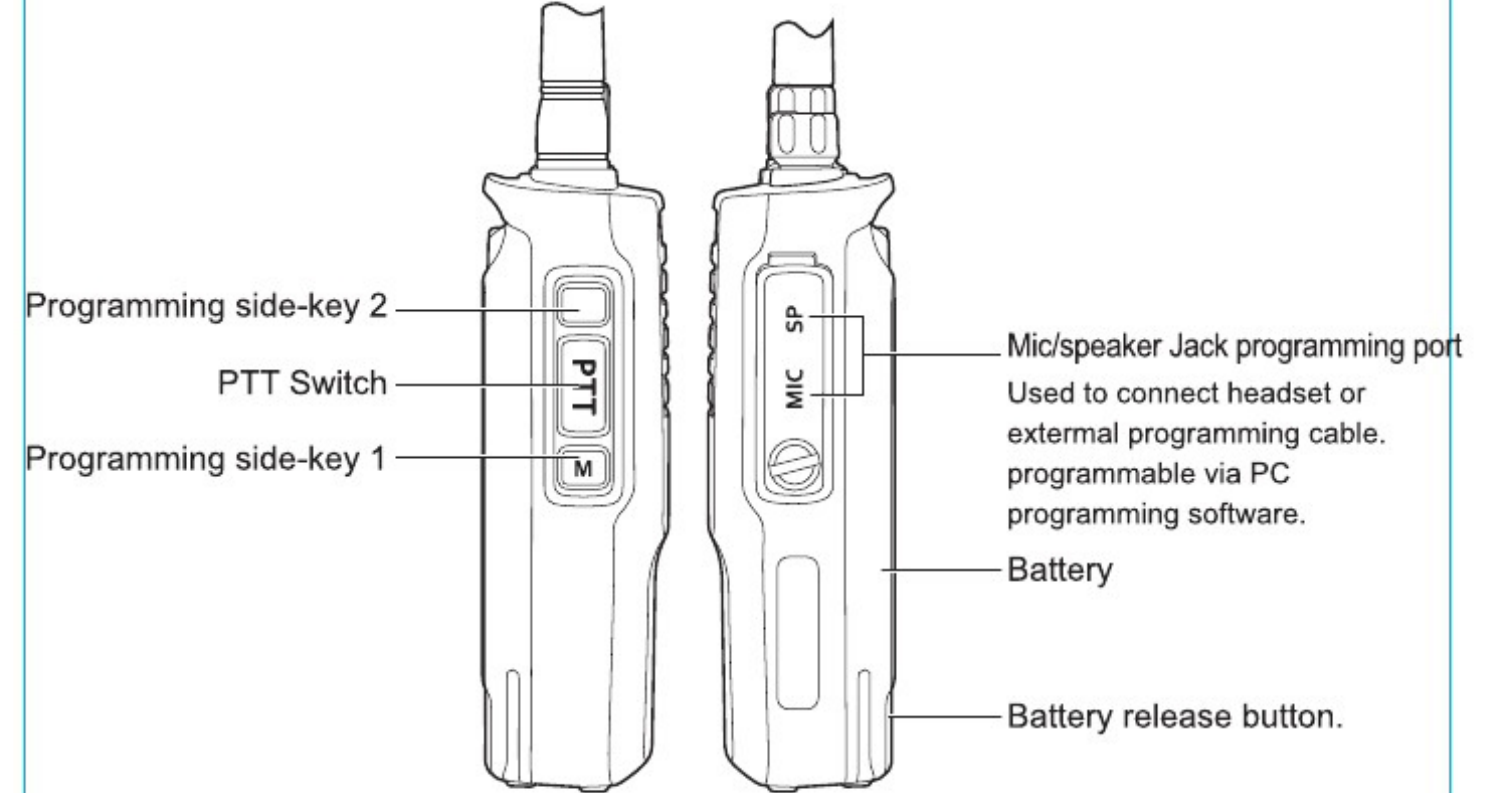
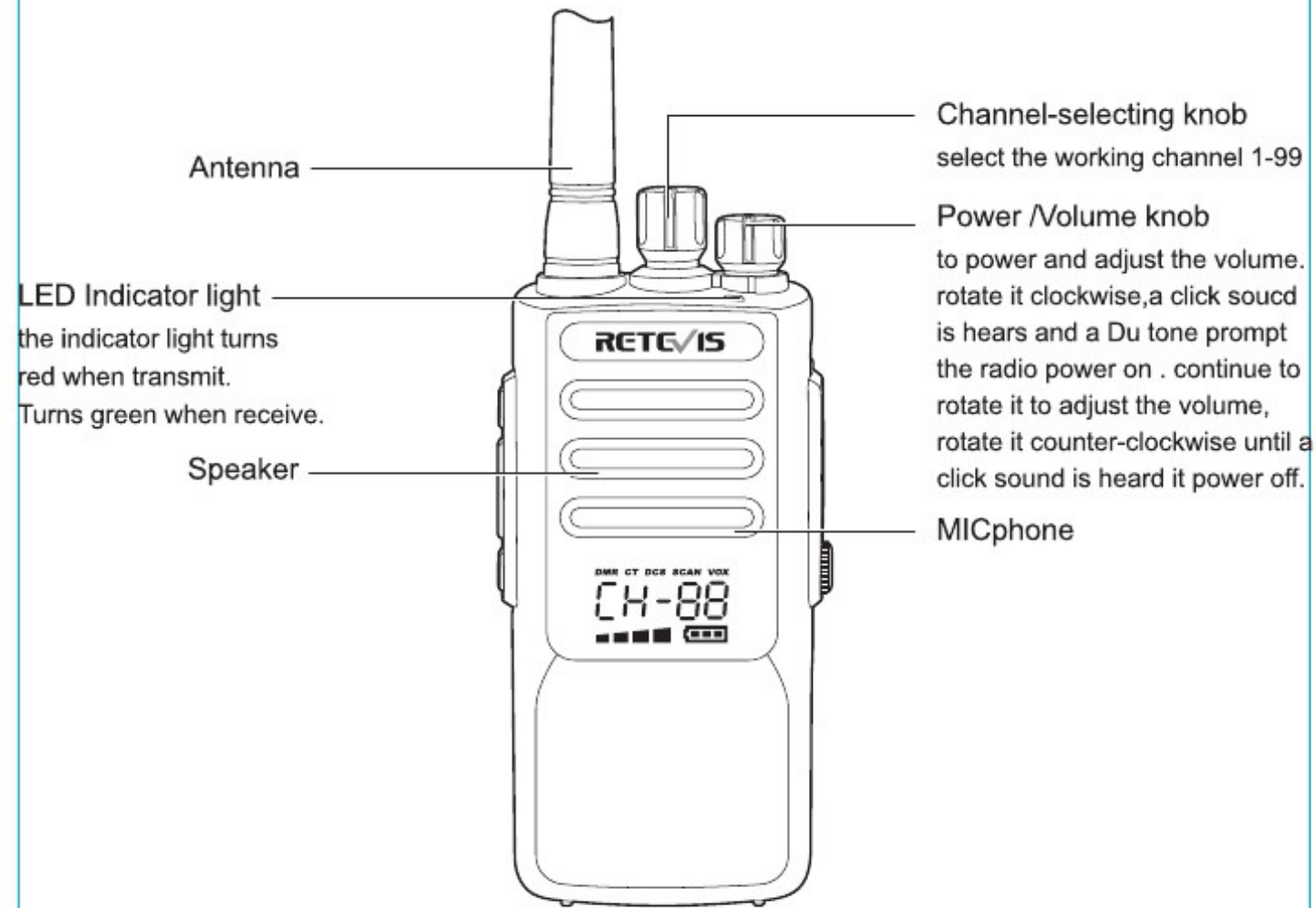



Note: Push the side key -1 and side key -2 can open the emergency call function while in emergency. But need programming the DMR radio software before using radios.

Digital Tube Character Function
Assignment Keys
Remote Kill/stun feature
Font feature LED Display
Radio Setting

Professional FM Transceiver

Digital Tube Character Function

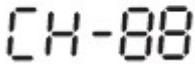

DMR	When the icon is bright, the current channel is digital channel; When the icon is not bright, the current channel is analog channel.
CT	When the icon is bright, the current channel is analog channel which has set the CTCSS signal.
DCS	When the icon is bright, the current channel is analog channel which has set the CTCSS signal.
SCAN	When the icon is bright, the Scan function is opened.
VOX	When the icon is bright, the VOX function is opened.
	The icon is means the current channel.
	Receiving radio shows 4 levels when the signal is strong; and shows 2 levels when the signal is weak.
	When the battery needs charged, the icon will flashes.

Assignment Keys

Users can set one of the following functions into the side key 1/side key 2

1. No set 2. High/low power 3. Scan 4. Repeater/Talkaround 5. Switch Zone
 6. One key 1 7. One key 2 8. One key 3 9. One key 4 10. One Key 5
 11. One key 6 12. VOX 13. TX digital deviation 14. Analog Monitor 15. 1750

Monitor

Press the side key that be programmed to the monitor, the radio will issue a squelch voice. This function can check the current channel is occupied or not before transmit. It can release anti-interference code (CTCSS/DCS) temporarily, also can receive the weak signal by this function, release the key to exit this function. (Notice: This function is invalid in digital channel.)

One Key

Touch the side key that be programmed to the One key 1/2/3/4/5/ can transmit the correspond calling.

VOX

Press the side key that be programmed to the VOX can choose open or close the VOX function. Speak to the microphone, it will open the transmitting and send the voice automatically; when stop speaking, the radio will stop transmitting and waiting for receiving automatically when your radio is opened the VOX function.

Switch Zone

Press the side key that be programmed to switch zone, you can choose the different zones set by programming software, the sound of "Di" means enter the Zone 2; the sound of "Di Di" means exit the Zone 2 and enter the Zone 1.

TX Digital Deviation

Press the side key which is programmed to radio activate to transmit detection code to detect the radio which open the detection decode.

High/Low Power Selection

Press the side key which is programmed to high/low power can switch the high/low power.

Repeater/Talkaround

Press the side key which is programmed repeater/talkaround can switch the repeater/talkaround. Talkaround, when use the talkaround function to communicate with handheld radio or correspond groups without repeater, the TX frequency will same as the RX frequency, the TX signal will same as RX signal.

1750

Please set the frequency or channel which you want to communicate with other radios by repeater, then long press the side key which is programmed 1750 to send the 1750Hz signal. Then release the side key, according to the normal way (press/release PTT key) to communication.

Encryption

If you enable the feature, which is beneficial to prevent other users on the channel by using the method of software encryption for unauthorized eavesdropping. the launch of signaling and user identification part unencrypted. Your radio must be enabled on the channel encryption function. Can send encrypted even if the receiving transmission is not must request to do so.

Basic Encryption

Two way radio can only be assigned more than one type of encryption, if users call for encryption or decryption of data transmission, must make to be preprogrammed walkie talkie and launch radio has the same encryption keys.

If your radio to receive different encryption keys or key values and key encryption call ID.

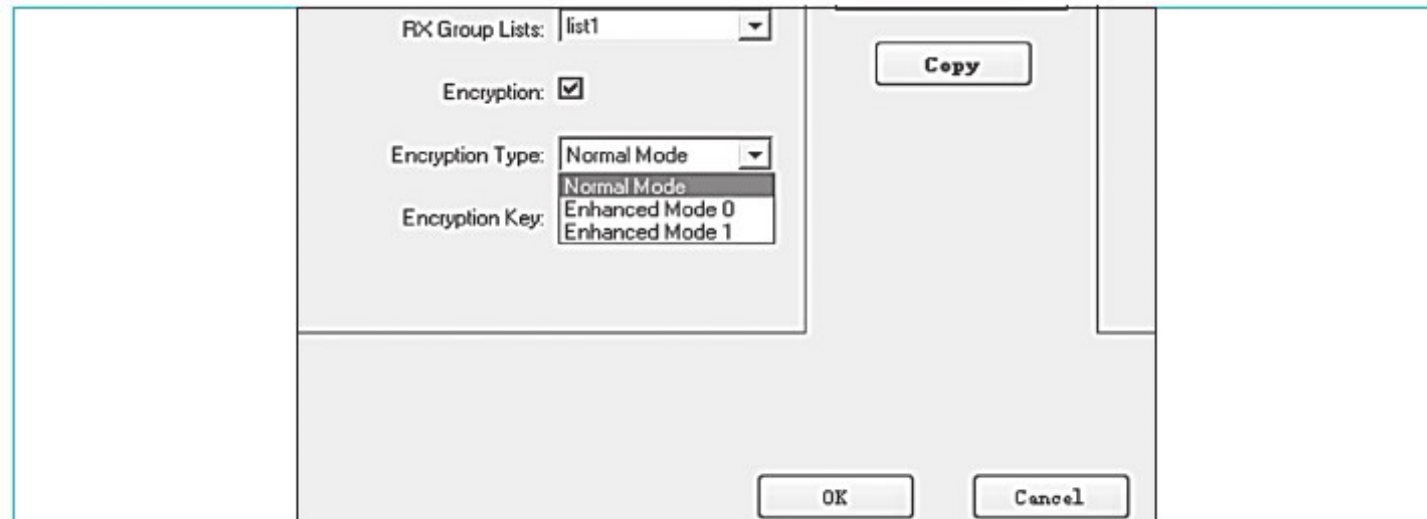

Press the preliminary programming encryption keys on or off.

Encryption type: If the common way can not Fit your encryption requirements, we also added two groups "enhanced encryption mode 0" and "enhance the encryption mode 1".

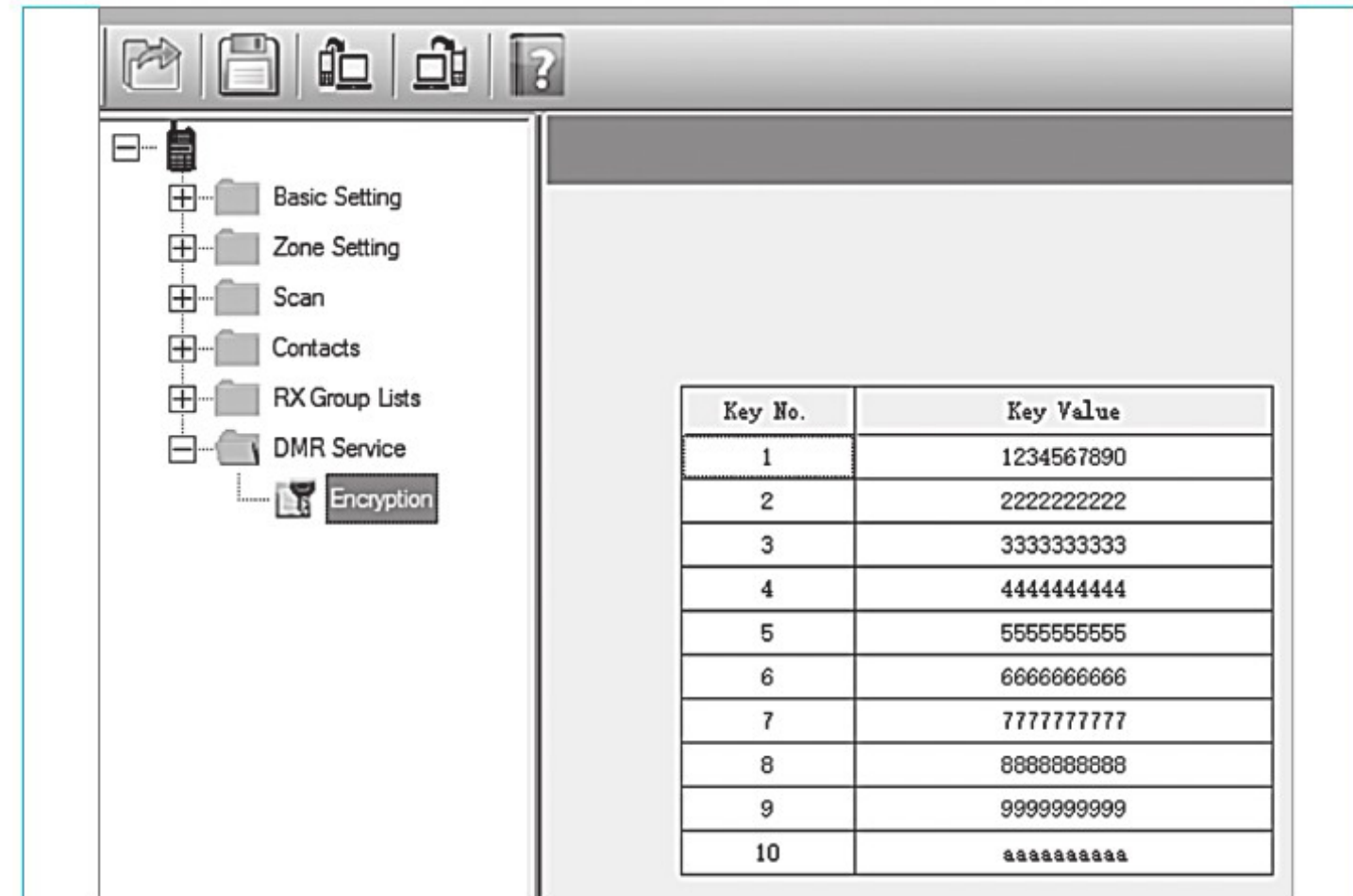
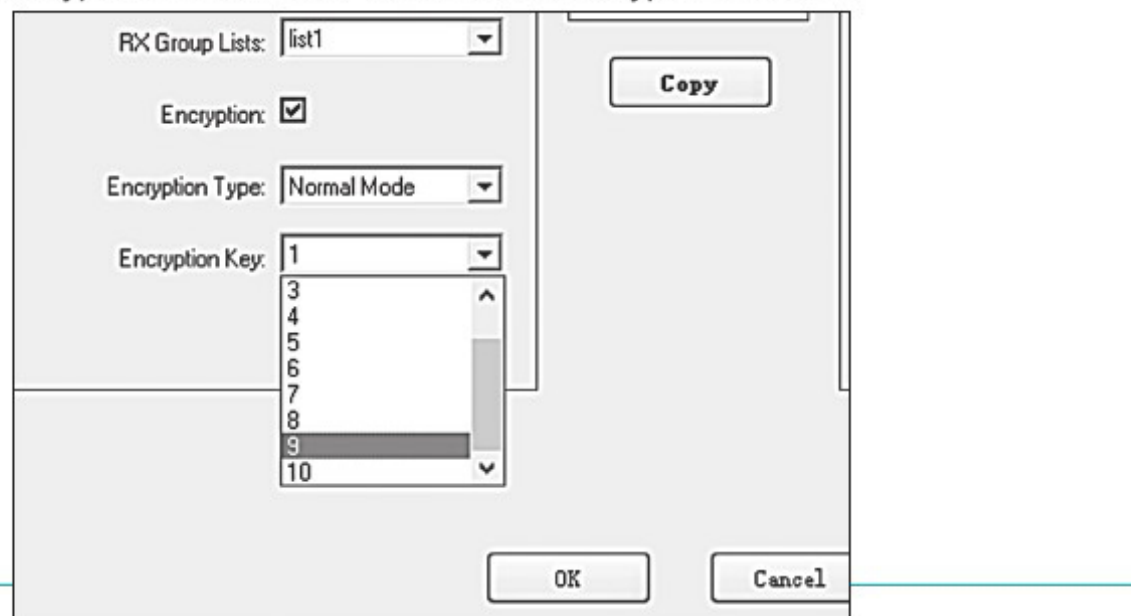

Encryption has 10 groups selectable, each group has top setting 10bit.

2-tone part

Step 1: edit the fast call list via programming software , radio can store up to 10group last calling list in total .

Step2: Input the encoding -requested A-tone , B tone and the gsp time between Atone and Btone.

The default setting is 100s.

In encoding,A tone will sound 1s while b tone will sound 3s ..but when there is only A tone in the call list as group call tone. A tone will sound 5s.Encoding only input Atone is available.Decoding group call code must same as Atone.

Step3: set the optional signal of the **DCS** to be 2 tone.

Enter programming software optional channel signaling , click the {more} after every frequency you edit. And save it to your radio.

Make 2 tone call with the transceiver

Power on LCD display show **DCS** it will be 2tone.Then setting it on side key .Choose optional signaling setting the 2tone code , Mean send the current signal.

5-tone part

Click in sequence: Program - optional feature -5 tone to program 5-tone ID and 5-tone international standard group.

Edit the optional signaling be 5tone in channel edit. Auto response switch on/off.

This radio has 8groups 5-tone encoder and decoder to support the different channels.

call/ transmit 5-tone operate

Lcd display show, choose optional signaling setting the 5 tone channel.

Setting it on side key. Choose optional signaling setting the 2 tone code, mean send the current signal.

Remote Kill/stun feature

Remote Kill: When the radio is kill , walkie-talkie cannot receive and cannot Transmit; can not be active If you want to make it activate only can via programming software(activation method: first read the data from radio, then choose "normal" in remote kill selectable, Then write the data to the radio and click save.

Remote skun: radio only can receive but not transmit while radio remote stun. Can be active.

Using remote remote skill or stun: please make the channel optional signaling be 5 tone .

Remote skill/stun for 2 tone And 5 tone version

A: Edit your skill code and stun code to your radio via programming software.

Skill code and stun code must be 7 bit number.

B: PTT ID has two transmit way : Transmit start, transmit finish, Push PTT start transmit. But you need Input the PTT ID code in programming software.

For example: Remote skun code: 1234567, remote skill code: 7654321, activate code: 234567. If you want to remote kill this radio, please write the PTT ID code to the programming software.Encoding the corresponding code.Choose both transmit way are available. Send 1234567 skill the radio. send the 234567 to the radio be activate. sending 7654321 to stun the radio.

Scrambler

Edit scrambler function on every able channel via software. Scrambler is one of the method for message encrypted.Scrambler realize the transmission spectrum through cepstrum change, the purpose of the transmitter reduction after receiving signals, so as to achieve a secret.

You can choose open or close this function from side key via programming software.

Compander

Edit compander function on every able channel via software. Voice compander technology mean that transmit the singal to receiver compander. Improve the voice quality and reduce the squelch.

Note: Only has this feature radio can be activate on communication,. Getting the high quality communicate voice.

You can choose open or close this function from side key via programming software.

Man down

One of feature for radio. Open this function via software and save. For example (picture) while radio tilt. As - + 60degree or - + 90degree. The radio will alert and ask others user or control center for help .

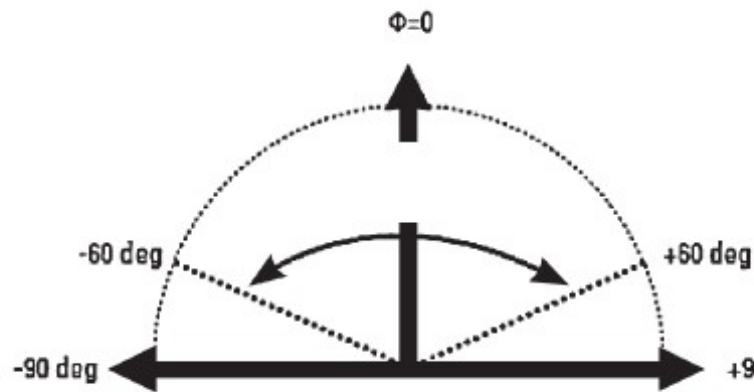

Font feature LED Display



DMR Light : Digital mode; close, analog mode

CT Light : With CTCSS/DCS in analog channels.

DCS Light : Means this channel has open encryption in digital mode. Open the 2/5tone, scrambler, compander in analog mode .

SCAN Light : Open scan feature.

VOX Light : Open VOX feature.

CH-88 Light : Current Channel.

■■■■ Transceiver show: singal strong while Full. Signal weak show 2 or less bar. Also mean transceiver high output power while full. low output power will be 2 or less bar.

🔋 Please charging battery ehile this icon flash.

Radio Setting

QT/DQT

1. If users set the QT/DQT signal in the channel, it can ignore other radio's transmitting in the same channel.
2. If one channel has set the QT/DQT, it will open the squelch when the radio received the same QT/DQT signal. Meanwhile, other radio can receive your transmit when the radio has set QT/DQT signal same as yours.
3. This radio has 50 groups of QT and 105 groups DQT for your selection.

Battery Save Function

When the radio do not have any operations and not receive any useful data or detect any useful carrier in a period time, the radio will enter the battery save mode. Receiving circuit and DSP enter a low power state in cycle to extend the use time of radio. Every time the radio is transmitting, according to the battery save mode settings, will send some pre carrier wave or voice head, in order to ensure that the sleep mode of the radio can be normally received. We call this time " Battery save mode delay time", which can be programmed by the programming software, ranging from 1s to 600s, the default value is 50s, users can choose whether to open the battery save mode.

Low Battery Alarm

When the voltage is lower than 5.8V, the radio is always in a low battery state, the red light flashed every 2s, and the radio makes the " low power" alarm, remind the end user to charger or replace the battery in time.

Communication Setting

Analog communication

Click "Zone 1" to add the analog channel (Open programming software-Zone setting-Zone 1)

Enter the channel setting.

Select channel bandwidth: 12.5K or 25K

Set the TX and RX frequency

Set the TX and RX QT/DQT

Set the RX squelch

Set the power

Set the TX authority

Click "Zone 1" to add the digital channel

Enter the channel setting, to set the color code, only the same color code can call on digital channel.

Set TX Frequency and RX Frequency

Set the RX group list (correspond to TX Contacts)

Set the TX Contacts (Users can set the Call type: Individual Call/Group Call/All Call)

Set the TX Authority: Impolite

Set the Contact

Contacts

Contacts only support for digital mode

Write click " Digital Contacts", and set the Call Type

Edit the corresponding ID

TX radio is able to select call the corresponding contacts

RX Group Lists

RX Group Lists only support digital mode

Select the contacts from RX Group Lists for group call (For communicating with TX radio)

Encryption

Select encryption type: Normal Mode/Enhanced Mode 0/Enhanced Mode 1

Set the key value of the corresponding key NO.

Enter the [Zone1], select digital channel, enter [RX Setting], click the Encryption

Select one encryption key

Only the same encryption ket can communication

Frequency table

Specifications

Troubleshooting guide

Guarantee

Professional FM Transceiver

CTCSS

CTCSS			
1-67.0	14-103.5	27-159.8	40-199.5
2-69.3	15-107.2	28-162.2	41-203.5
3-71.9	16-110.9	29-165.5	42-206.5
4-74.4	17-114.8	30-167.9	43-210.7
6-79.7	19-123.0	32-173.8	45-225.7
7-82.5	20-127.3	33-177.3	46-229.1
8-85.4	21-131.8	34-179.9	47-233.6
9-88.5	22-136.5	35-183.5	48-241.8
10-91.5	23-141.5	36-186.2	49-250.3
11-94.8	24-146.2	37-189.9	50-254.1
12-97.4	25-151.4	38-192.8	
13-100.0	26-156.7	39-196.6	

DCS

DCS								
023	071	143	225	266	356	452	532	664
025	072	145	226	271	364	454	546	703
026	073	152	243	274	365	455	565	712
031	074	155	244	306	371	462	606	723
032	114	156	245	311	411	464	612	731
036	115	162	246	315	412	465	624	732
043	116	165	251	325	413	466	627	734
047	122	172	252	331	423	503	631	743
051	125	174	255	332	431	506	632	754
053	131	205	261	343	432	516	645	
054	132	212	263	346	445	523	654	
065	134	223	265	351	446	526	662	

Specifications

Main technical indicators

Frequency range	VHF:136-174MHz or UHF:400-480MHz
Channel	198
Operating Voltage	7.4V
Operating Temperature	-30°C+60°C
Antenna Impedence	50Ω
Store temperature	-40°C+65°C

Receiver

Analog sensibility	0.35uV/-116dbm(20db SINDA) 0.22uv/-120dbm(type)
Digital Sensibility	0.3uV/-117.4dbm(BER5%) 0.22uv/-110dbm(BER1%)
Channel spacing	12.5KHz
Frequency stability	+/-1.0ppm
intermodulation	TIA603C:65DB ETSI65DB
Adjacent channel selectivity	TIA603C:60DB@12.5KHZ ETSI60DB@12.5KHZ
Co-channel Rejection	12DB@12.5KHZ
Spurious response	TIA603C:70DB ETSI70DB MAIL TO 60DB@12.5KHZ

Spurious Radiation	<-57DBM@1GHZ >-47DBM@1GHZ
Block	84db
Audio power	1w
Audio response	+1db- - 3db
Rated audio distortion	<=3%

Transmitter

Channel spacing	12.5KHZ
Frequency stability	+/-1.5PPM
Output power	Low:5w high :10W
Hum and Noise	-40DB@12.5KHZ
Receive Spurious Radiation	<-36DBM@1GHZ >-30DBM@1GHZ
Adjacent channel power	-60DBM@12.5KHZ
FM Modulation Mode	12.5KHZ:11F0F3E
4FSK Digital Mode	12.5KHZ(DATE ONLY):7K60FXD 12.5KHZ(DATE +VOICE):7K60FXE
Modulation Maximum Deviation	2.5KHZ@12.5KH
Audio response	+1DB - -3DB
Modilation BER	<=3%
Digital protocol	ETSI TS 102 361-1-2-3
Vocoder type	AMBE+2TM

Note: specifications will be revised without notice due to technical improvement. Thank you !

Trouble shooting guide

Troubles	Solution
No Electrical Source	<ul style="list-style-type: none"> ● The battery has been exhausted. Replace or recharge the battery. ● The battery is installed incorrectly. Remove it and install again.
The operating time becomes short, even the battery is fully charged.	<ul style="list-style-type: none"> ● Replace the battery.
Not able to communicate with the transceivers of the same group.	<ul style="list-style-type: none"> ● Confirm the QT/DQT is the same. The distance is outside of range.
The voice of another group can be heard.	<ul style="list-style-type: none"> ● Change all QT/DQT of the group.
Other radios can not receive the TX signals or receive signals in a low volume.	<ul style="list-style-type: none"> ● Switch the volume knob to the highest level ● The microphone may be damaged, send it to the local dealer for check.
Noise is always heard.	<ul style="list-style-type: none"> ● The distance is outside of range. Turn on the radio in nearer range and try again.

Rf Energy Exposure And Product Safety Guide For Portable Two-way Radios



ATTENTION!

Before using this radio, read this guide which contains important operating instructions for safe usage and RF energy awareness and control for compliance with applicable standards and regulations.

This two-way radio uses electromagnetic energy in the radio frequency (RF) spectrum to provide communications between two or more users over a distance. It uses radio frequency (RF) energy or radio waves to send and receive calls. RF energy is one form of electromagnetic energy. Other forms include, but are not limited to, sunlight and x-rays. RF energy, however, should not be confused with these other forms of electromagnetic energy, which when used improperly, can cause biological damage. Very high levels of x-rays, for example, can damage tissues and genetic material.

Experts in science, engineering, medicine, health, and industry work with organizations to develop standards for safe exposure to RF energy. These standards provide recommended levels of RF exposure for both workers and the general public. These recommended RF exposure levels include substantial margins of protection.

All Retevis two-way radios are designed, manufactured, and tested to ensure they meet government-established RF exposure levels. In addition, manufacturers also recommend specific operating instructions to users of two-way radios. These instructions are important because they inform users about RF energy exposure and provide simple procedures on how to control it.

Please refer to the following websites for more information on what RF energy exposure is and how to control your exposure to assure compliance with established RF exposure limits:

<http://www.who.int/en/>

Local Government Regulations

When two-way radios are used as a consequence of employment, the Local Government Regulations requires users to be fully aware of and able to control their exposure to meet occupational requirements. Exposure awareness can be facilitated by the use of a product label directing users to specific user awareness information. Your Retevis two-way radio has a RF Exposure Product Label. Also, your Retevis user manual, or separate safety booklet includes information and operating instructions required to control your RF exposure and to satisfy compliance requirements.

Radio License

Governments keep the radios in classification, most of the classified walkie-talkie need to get local government License, and operation is allowed. The detailed classification and the use of your two way radios, please contact the local government radio management departments.

For the following specified classification: the USA FRS, Australian CB, the individual license is not required.

Compliance with RF Exposure Standards (If appropriate, Reference to the actual product's Safety Marking)

Your Retevis two-way radio is designed and tested to comply with a number of national and

International standards and guidelines (listed below) for human exposure to radio frequency electro-magnetic energy.

FCC ID The FCCID means: This radio complies with the IEEE (FCC) and ICNIRP exposure limits RF exposure environments at operating duty factors of up to 50% talk-50% listen and is approved for occupational use only.

CE The CE marking means: Hereby, Shenzhen Retevis Technology Co., Ltd. declares that the radio equipment type this radio is in compliance with the RED Directive 2014/53/EU and the ROHS Directive 2011/65/EU and WEEE Directive 2012/12/EU.

The full text of the EU declaration of conformity is available at the following internet address: www.retevis.com.

IC ID This device complies with Industry Canada RSS standard(s). Operation is subject to the following two conditions:

- (1) This device may not cause interference, and
- (2) This device must accept any interference, including interference that may cause undesired operation of the device.

In terms of measuring RF energy for compliance with these exposure guidelines, your radio generates measurable RF energy only while it is transmitting (during talking), not when it is receiving (listening) or in standby mode.

NOTE: The approved batteries, supplied with this radio, are rated for a 5-5-90 duty factor(5% talk-5% listen-90% standby) even though this radio complies with FCC occupational exposure limits and may operate at duty factors of up to 50% talk.

RF energy exposure standards and guidelines (if appropriate)

Your Retevis two-way radio complies with the following RF energy exposure standards and guidelines:

- United States Federal Communications Commission (FCC), Code of Federal Regulations; 47 CFR part 2 sub-part J.
- American National Standards Institute (ANSI)/Institute of Electrical & Electronic Engineers (IEEE) C95. 1-2005
- IEEE Std. 1528:2013 and KDB447498, Evaluating Compliance with FCC Guidelines for Human Exposure to Radio Frequency Electromagnetic Fields.
- Institute of Electrical and Electronic Engineers (IEEE) C95.3-2002
- International Commission on Non-Ionizing Radiation Protection (ICNIRP)
- Ministry of Health (Canada) Safety Code 6 & Industry Canada RSS-102.
- International Electrotechnical Com-mission IEC62209-2:2010

RF Exposure Compliance and Control Guidelines and Operating Instructions

To control your exposure and ensure compliance with the occupational/controlled environment exposure limits, always adhere to the following procedures.

Guidelines

- User awareness instructions should accompany the device when transferred to other users.
- Do not use this device if the operational requirements described herein are not met.

Operating Instructions

- Transmit no more than the rated duty factor of 50% of the time. To Transmit (Talk), push the

Push To Talk (PTT) button. To receive calls (listen), release the PTT button. Transmitting 50% of the time, or less, is important because the radio generates measurable RF energy exposure only when transmitting in terms of measuring for standards compliance.

- Transmit only when people outside the vehicle are at least the recommended minimum lateral distance away from a properly installed according to installation instructions, externally mounted antenna.
- When operating in front of the face, worn on the body, always place the radio in a Retevis approved clip, holder, holster, case, or body harness for this product. Using approved body-worn accessories is important because the use of Non-Retevis approved accessories may result in exposure levels, which exceed the IEEE/ICNIRP occupational/controlled environment RF exposure limits.
- If you are not using a body worn accessory and are not using the radio in the intended use position, in front of the face or at the body in the PTT mode or alongside of the head in the phone mode, then ensure the antenna and the radio are kept 2.5 cm (one inch) from the body when transmitting. Keeping the radio at a proper distance is important because RF exposures decrease with increasing distance from the antenna.

Hand-held Mode

- Hold the radio in a vertical position with the microphone (and other parts of the radio including the antenna) at least 2.5 cm (one inch) away from the nose or lips. The antenna should be kept away from the eyes. Keeping the radio at a proper distance is important as RF exposure decreases with increasing distance from the antenna.



Phone Mode

- When placing or receiving a phone call, hold your radio product as you would a wireless telephone. Speak directly into the microphone.

Electromagnetic Interference/Compatibility

NOTE: Nearly every electronic device is susceptible to electromagnetic interference (EMI) if inadequately shielded, designed, or otherwise configured for electromagnetic compatibility.

Avoid Choking Hazard



Small Parts. Not for children under 3 years.

Turn off your radio power in the following conditions:



WARNING

- Turn off your radio before removing (installing) a battery or accessory or when charging battery.
- Turn off your radio when you are in a potentially hazardous environments: Near electrical blasting caps, in a blasting area, in explosive atmospheres (flammable gas, dust particles, metallic powders, grain powders, etc.).
- Turn off your radio while taking on fuel or while parked at gasoline service stations.

To avoid electromagnetic interference and/or compatibility conflicts

- Turn off your radio in any facility where posted notices instruct you to do so, hospitals or health care facilities (Pacemakers, Hearing Aids and Other Medical Devices) may be using equipment that is sensitive to external RF energy.
- Turn off your radio when on board an aircraft. Any use of a radio must be in accordance with applicable regulations per airline crew instructions.

Note:

Pacemakers

Defibrillators or other Implanted Medical Devices Persons with pacemakers, Implantable Cardioverter-Defibrillators (ICDs) or other active implantable medical devices (AIMD) should:

- ALWAYS keep the radio more than 15 cm from their pacemaker when the radio is turned on.
- Consult with their physicians regarding the potential risk of interference from radio frequency transmitters, such as portable radios (poorly shielded medical devices may be more susceptible to interference).
- Turn the radio OFF immediately if they have any reason to suspect that interference is taking place.
- Do not carry the radio in a chest pocket or near the implantation site, and carry or use the radio on the opposite side of their body from the implantable device to minimize the potential for interference.

Hearing Aids

Some digital wireless radios may interfere with some hearing aids. In the event of such interference, you may want to consult your hearing aid manufacturer to discuss alternatives.

Other Medical Devices

If you use any other personal medical device, consult the manufacturer of your device to determine if it is adequately shielded from RF energy. Your physician may be able to assist you in obtaining this information.

Protect your hearing:



WARNING

- Use the lowest volume necessary to do your job.
- Turn up the volume only if you are in noisy surroundings.
- Turn down the volume before adding headset or earpiece.
- Limit the amount of time you use headsets or earpieces at high volume.
- When using the radio without a headset or earpiece, do not place the radio's speaker directly against your ear.

Note: Exposure to loud noises from any source for extended periods of time may temporarily or permanently affect your hearing. The louder the radio's volume, the less time is required before your hearing could be affected. Hearing damage from loud noise is sometimes undetectable at first and can have a cumulative effect.

Avoid Burns



WARNING

Antennas

- Do not use any portable radio that has a damaged antenna. If a damaged antenna comes into contact with the skin when the radio is in use, a minor burn can result.

Batteries (If appropriate)

- When the conductive material such as jewelry, keys or chains touch exposed terminals of the batteries, may complete an electrical circuit (short circuit the battery) and become hot to cause bodily injury such as burns. Exercise care in handling any battery, particularly when placing it inside a pocket, purse or other container with metal objects.

Long transmission

- When the transceiver is used for long transmissions, the radiator and chassis will become hot.

Safety Operation



WARNING

Forbid

- Do not use charger outdoors or in moist environments, use only in dry locations/conditions.
- Do not disassemble the charger, that may result in risk of electrical shock or fire.

- Do not operate the charger if it has been broken or damaged in any way.
- Do not place a portable radio in the area over an air bag or in the air bag deployment area. The radio may be propelled with great force and cause serious injury to occupants of the vehicle when the air bag inflates.

To reduce risk

- Pull by the plug rather than the cord when disconnecting the charger.
- Unplug the charger from the AC outlet before attempting any maintenance or cleaning.
- Contact Retevis for assistance regarding repairs and service.

Use of Communication Devices While Driving

- Always check the laws and regulations on the use of radios in the countries and areas where you drive.
- Give your full attention to driving and to the road.
- If available, use the hands-free facility.
- If driving conditions or regulations require it, pull off the road and park before making or answering a call.

Approved Accessories**WARNING**

- This radio meets the RF exposure guidelines when used with the Retevis accessories supplied or designated for the product. Use of other accessories may not ensure compliance with the RF exposure guidelines and may violate regulations.
- For a list of Retevis-approved accessories for your radio model, visit the following website: www.Retevis.com

EU Importer:**Importer: Germany Retevis Technology GmbH****Address: Uetzenacker 29,38176 Wendeburg**



Warranty card

Note:

1. This warranty card is only applicable to two-way radio of the above-listed model and serial number.
2. The warranty card is an important document for the end-user to enjoy warranty service, please keep it well.
3. The warranty card shall be filled and chopped by the dealer, or it is invalid.

Customer's name: _____

Gender: _____

Add and postal code: _____

Customer's Tel: _____

Model: _____

Serial number: _____

Purchasing date: _____

Invoice No.: _____

Dealer: _____

Stamp: _____

Add and postal code of the dealer: _____

Contact Tel: _____

Handling people: _____

Thank you for buying two-way radios, we will do our best to provide you with a stable, clear and efficient wireless communication services. In order for you to enjoy a better quality warranty service, please focus on the following information:

The products warranty period begins from the purchasing date, if product failure under normal use within warranty period occurs, according to the contents of this warranty, (the radio is guaranteed for 12 months, accessories 6 months), please carry the warranty card originals and purchase invoice to designated authorized warranty repair station for warranty service.

The following situations occur during warranty period will be implemented in paid service:

- (1) Failure to produce the warranty card
- (2) The card has altered traces or inconsistent with the product
- (3) Defect or damage caused by abnormal or non-normal use
- (4) Defect or damage caused by misuse, accident, water or negligence
- (5) Defect or damage caused by improper testing, operation, maintenance, installation, disassembly or adjustment
- (6) Defect or damage caused by unauthorized repair or disassembly
- (7) Defect or damage caused by force majeure
- (8) Wear and tear under normal use

When you are in need of repair, please send the radio, warranty card and purchase invoice together by post or take directly to designated authorized service stations, shipping costs should be borne by the user.

Maintenance record

Carry-in date			
Completion date			
Fault description			
Maintenance staff numbers			
Maintenance personnel No.			
Signature			

This warranty card to be kept by the user, no replenishment if lost